



YJQ20N04A

N-Channel Enhancement Mode Field Effect Transistor

Product Summary

DS

40

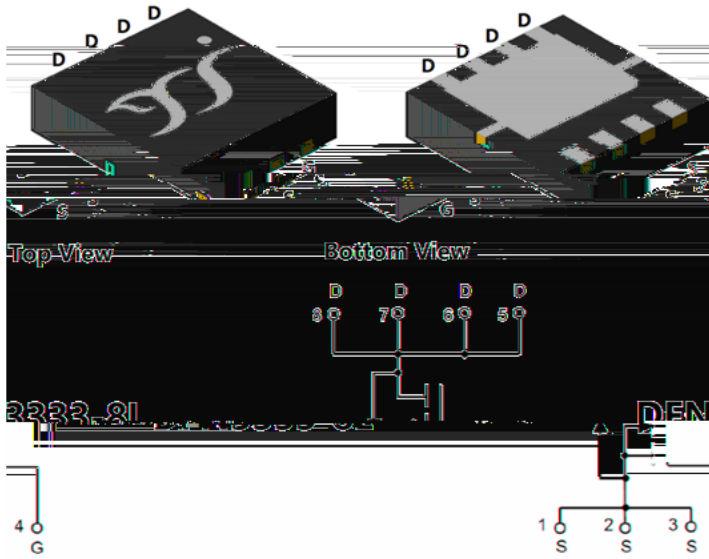

YJQ20



Typical Performance Characteristics

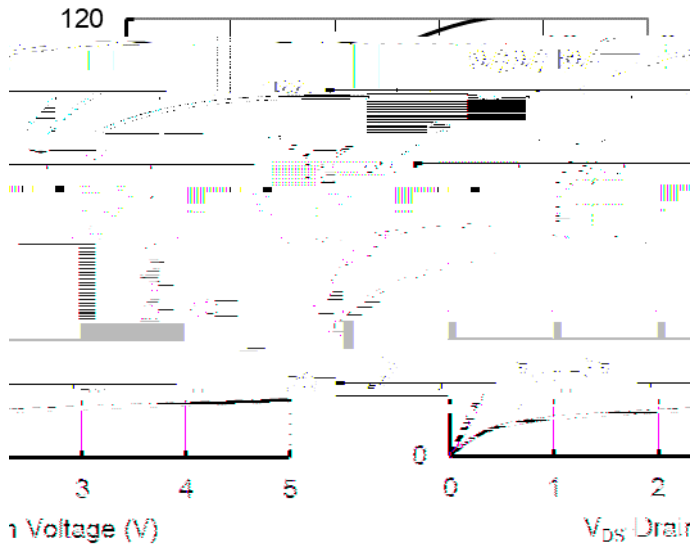

Figure 1. Output Characteristics

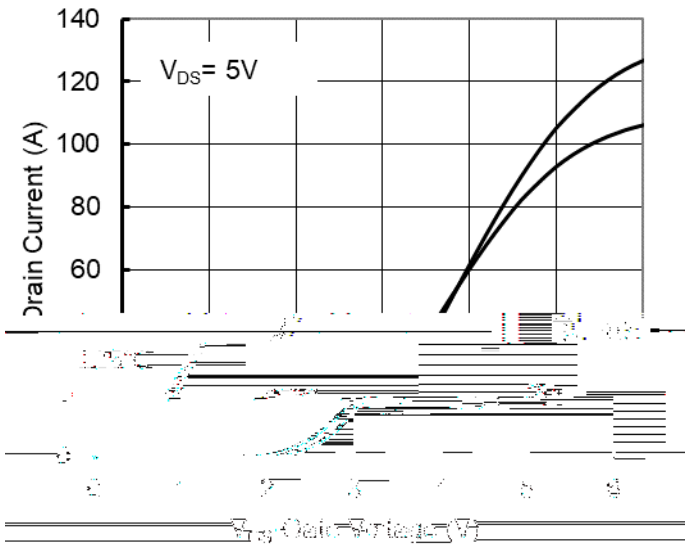

Figure 2. Transfer Characteristics

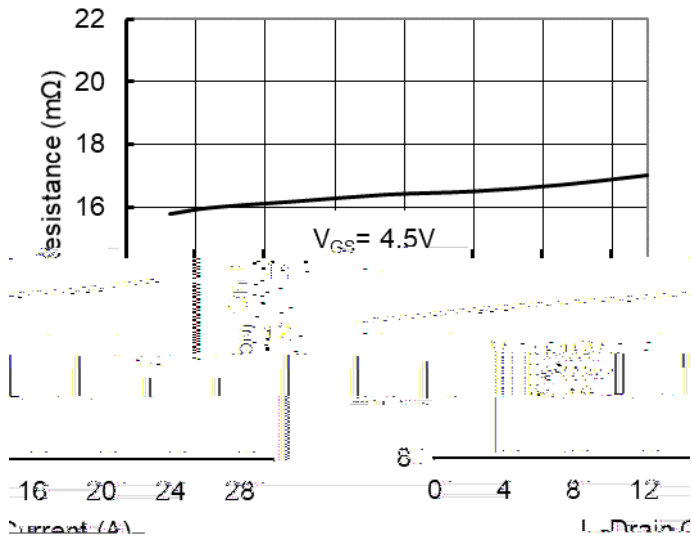

Figure 3. On-Resistance vs. Drain Current and Gate Voltage

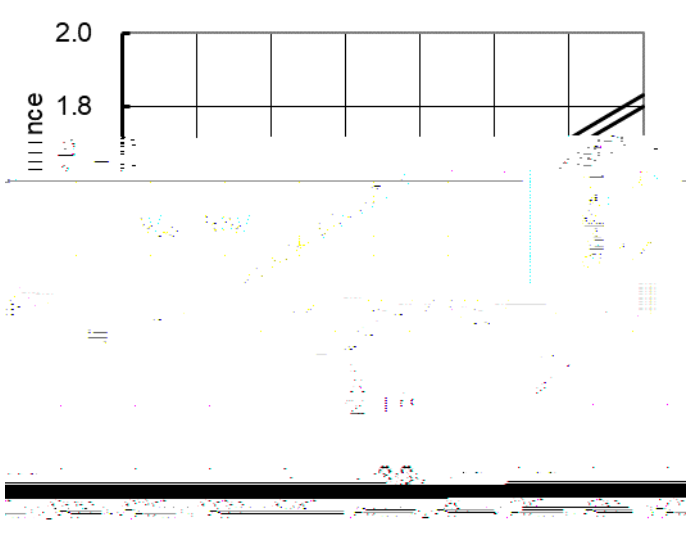

Figure 4. On-Resistance vs. Junction Temperature

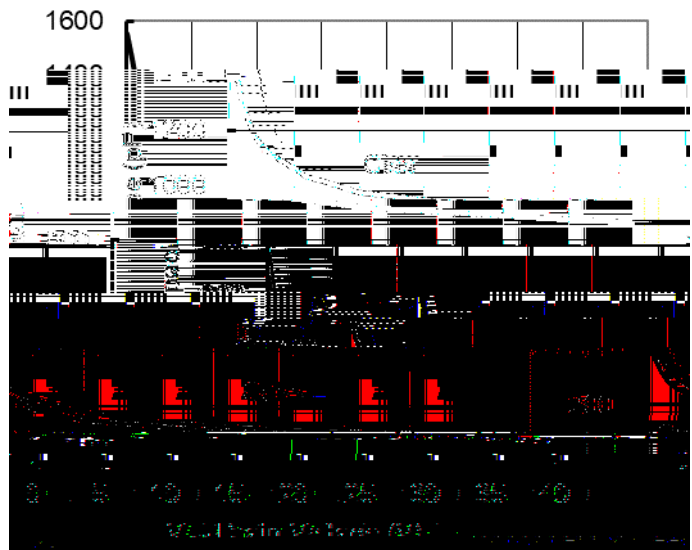

Figure 5. Capacitance Characteristics

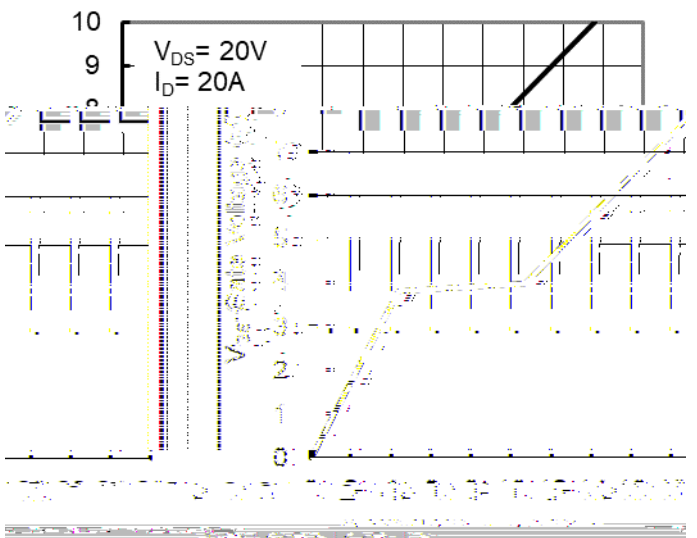
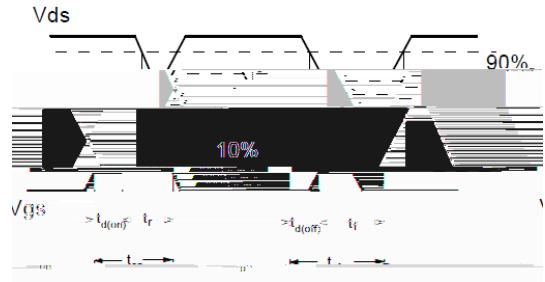
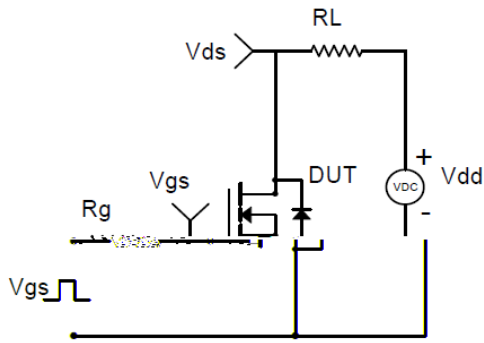
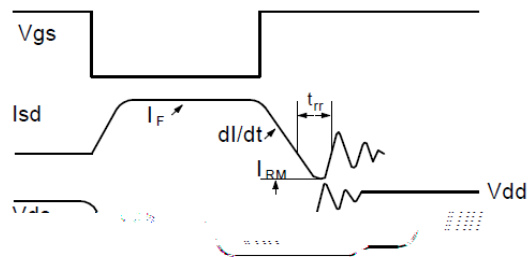
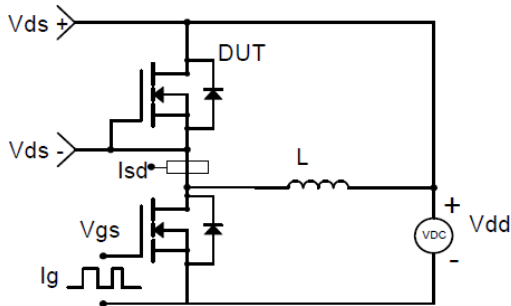

Figure 6. Gate Charge



Resistive Switching Test Circuit & Waveforms



Diode Recovery Test Circuit & Waveforms

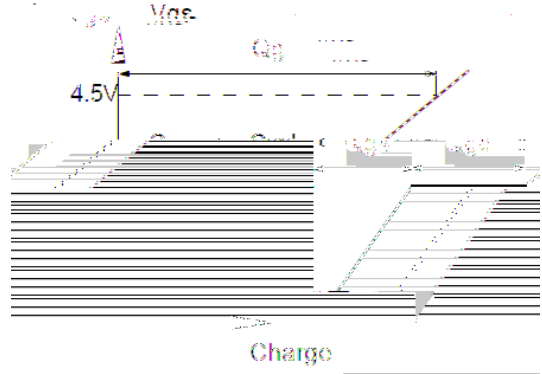

Gate Charge Test Circuit & Waveform

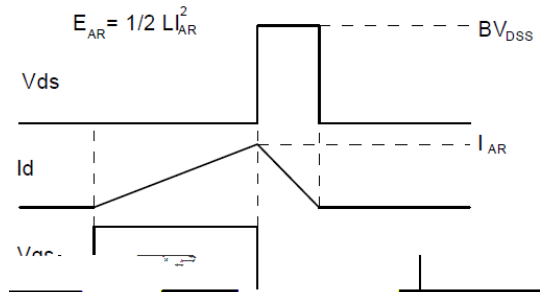
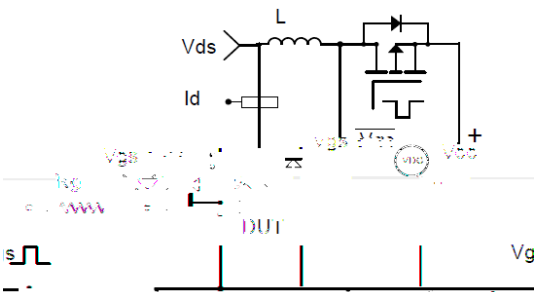

Unclamped Inductive Switching (UIS) Test Circuit & Waveforms



YJQ20N04A

DFN3333-8L-A-0.8MM Package information

