



# YJJ3400B

---

## N-Channel Enhancement Mode Field Effect Transistor

### Product Summary

$V_{DS}$	30V
$I_D$	5.6A
$R_{DS(ON)}$ ( at $V_{GS}$	





## Typical Electrical and Thermal Characteristics Diagrams

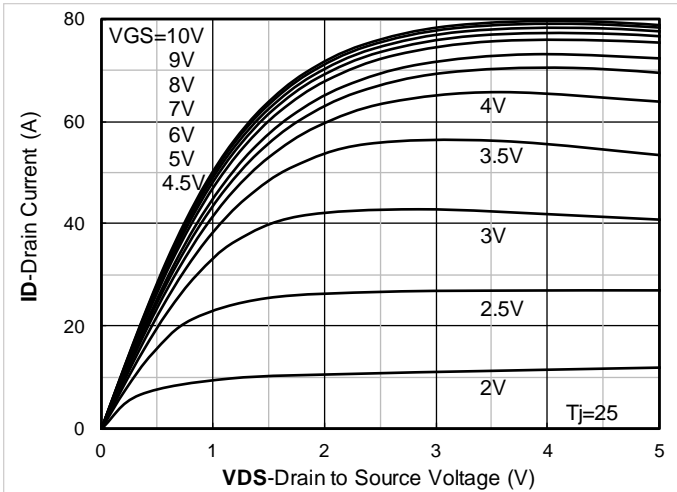

Figure 1. Output Characteristics

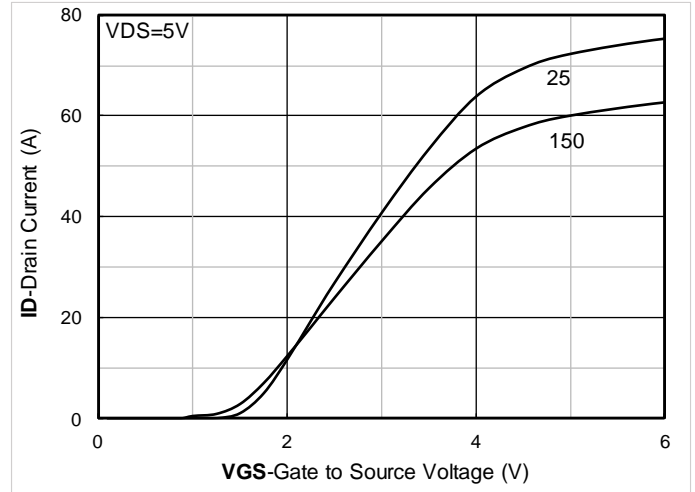

Figure 2. Transfer Characteristics

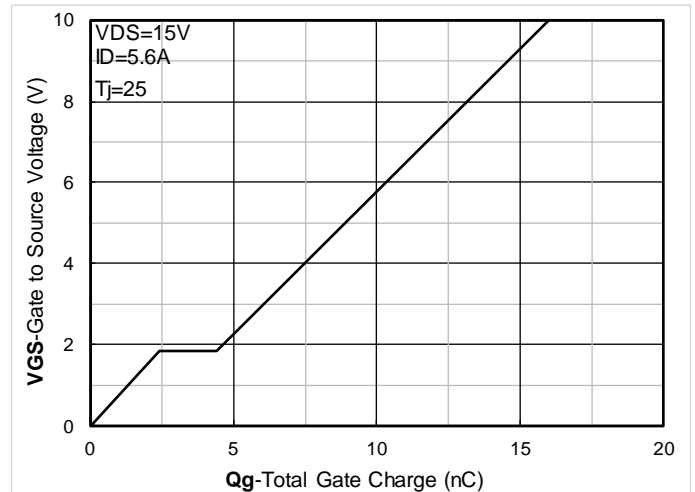

Figure 3. Capacitance Characteristics

Figure 4. Gate Charge

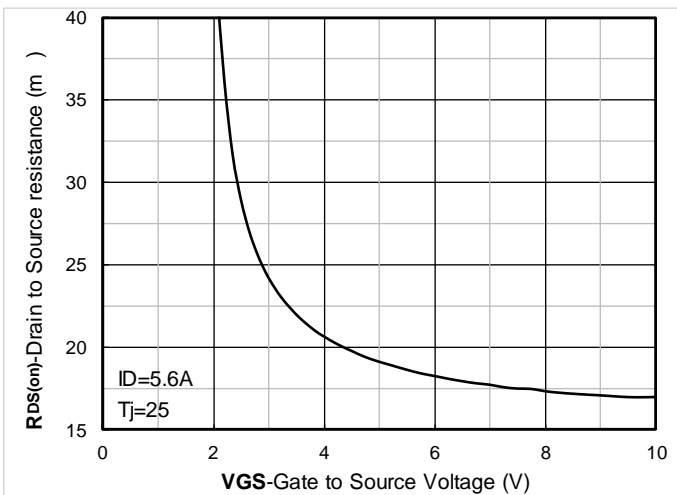

Figure 5. On-Resistance vs Gate to Source Voltage

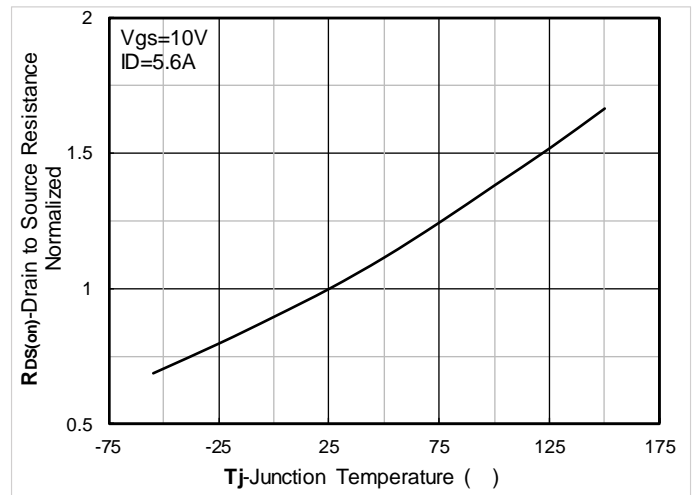

Figure 6. Normalized On-Resistance



# YJJ3400B

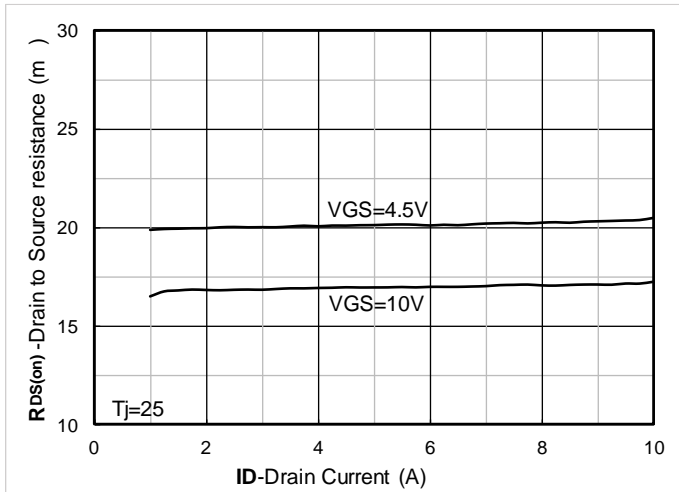

Figure 7. RDS(on) VS Drain Current

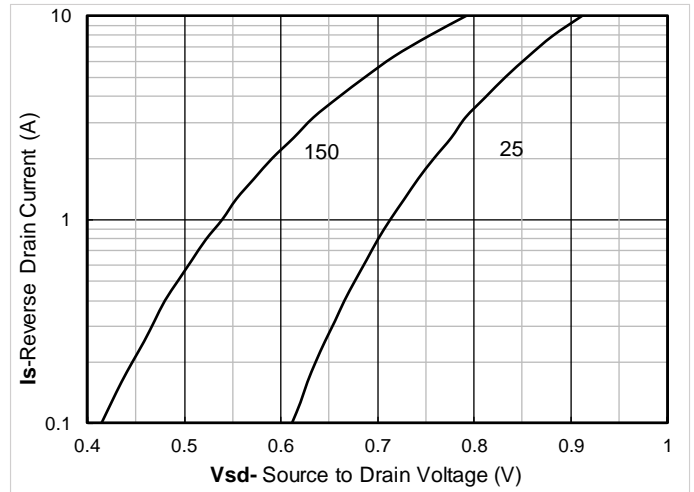

Figure 8. Forward characteristics of reverse diode

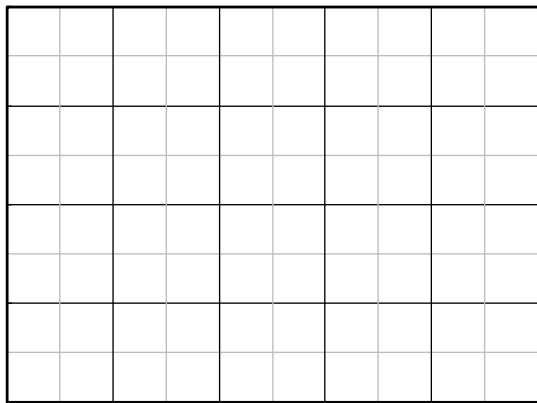

Figure 9. Normalized breakdown voltage

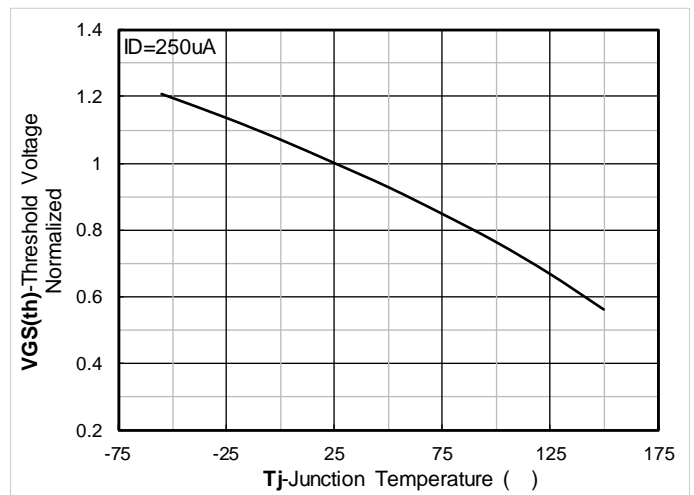

Figure 10. Normalized Threshold voltage

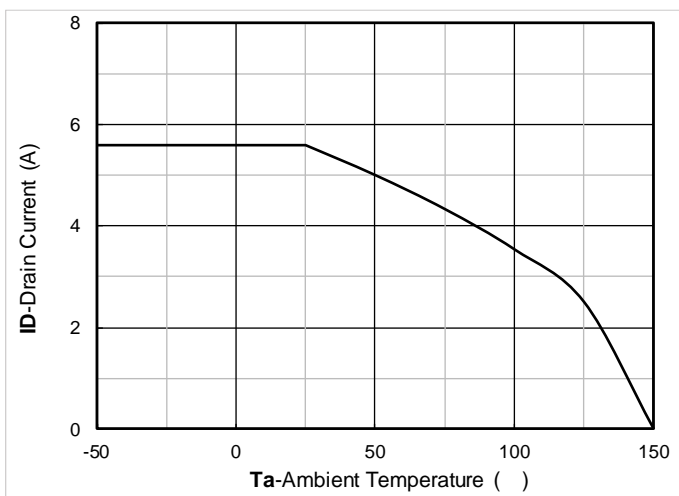

Figure 11. Current dissipation

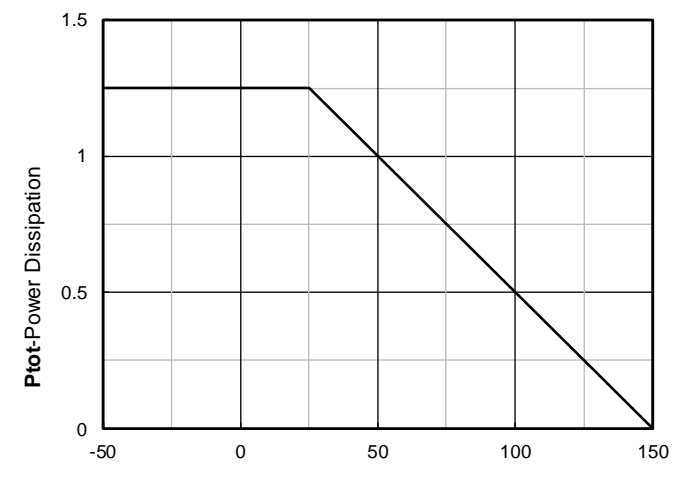

Figure 12. Power dissipation



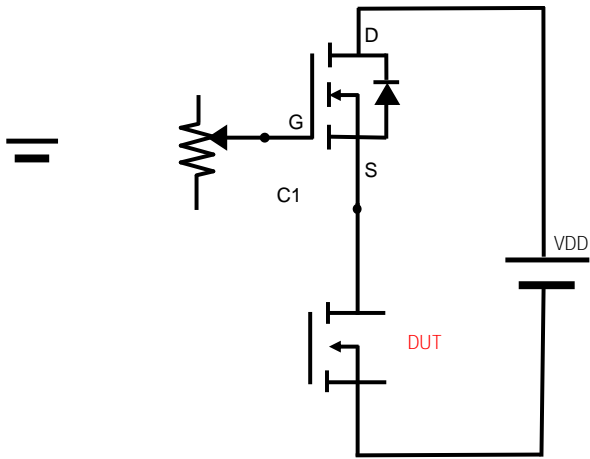
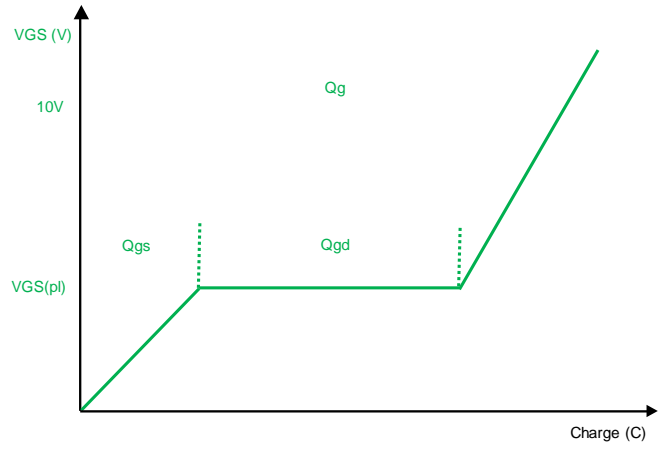
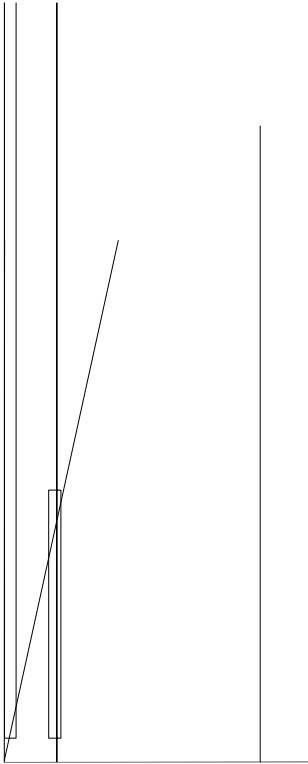

Figure B. G





## SOT-23-6L Package information



DIMENSIONS				
SYMBOL	INCHES		Millimeter	
	MIN.	MAX.	MIN.	MAX.
A	0.012	0.020		
B	0.059	0.067		
C	0.104	0.116		
D				
G				
H				
J				
K	0.041	0.045	1.050	1.150
L	0.012	0.024	0.300	0.600
M	0.004	0.008	(	
	0°	8°	0°	8°

