



Electrical Characteristics ($T_J=25$ unless otherwise noted)



Typical Electrical and Thermal Characteristics Diagrams

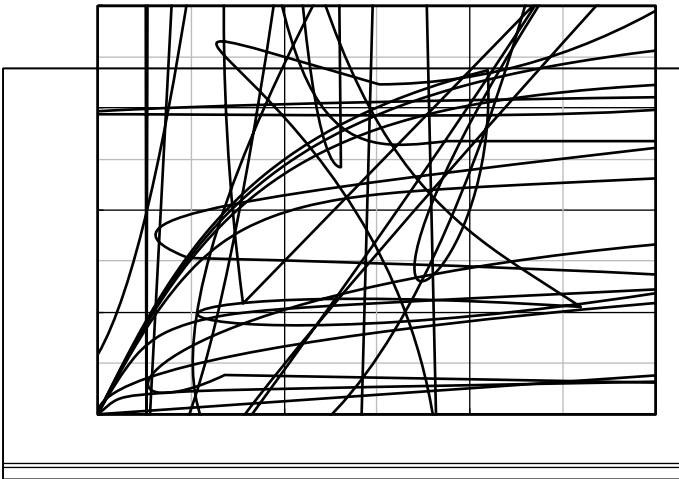

Figure 1. Output Characteristics

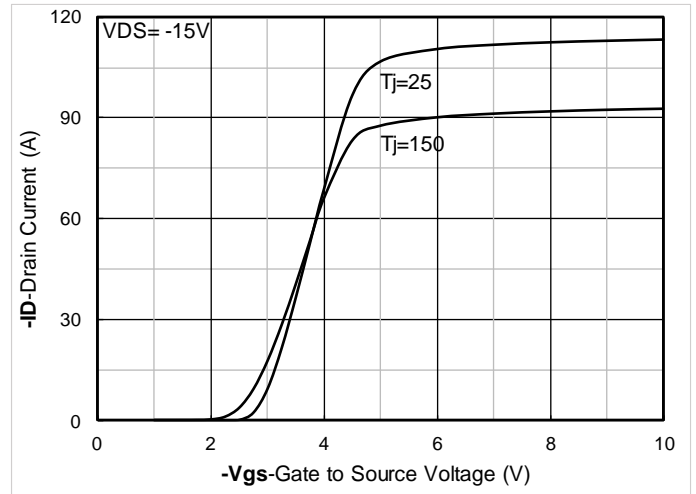

Figure 2. Transfer Characteristics

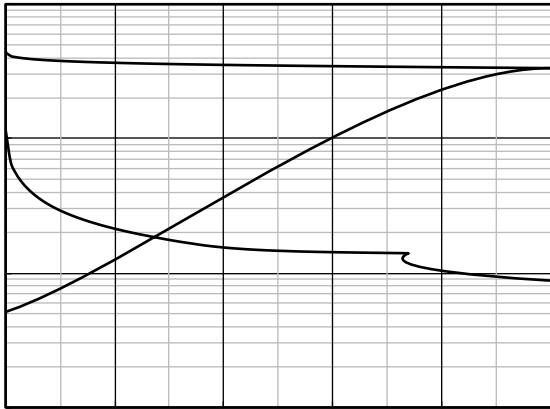

Figure 3. Capacitance Characteristics

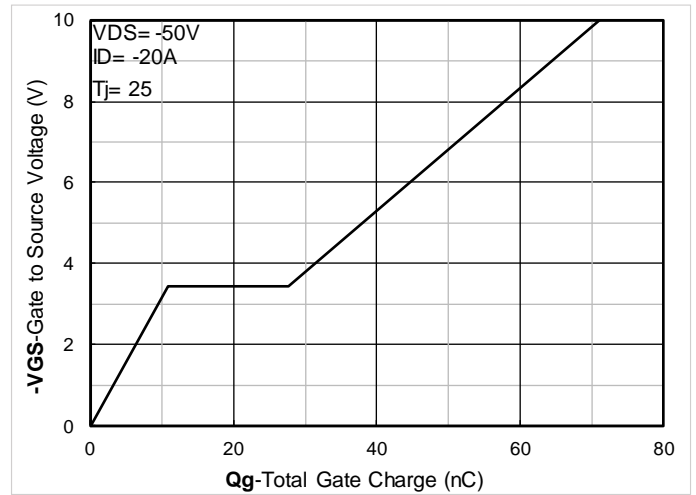

Figure 4. Gate Charge

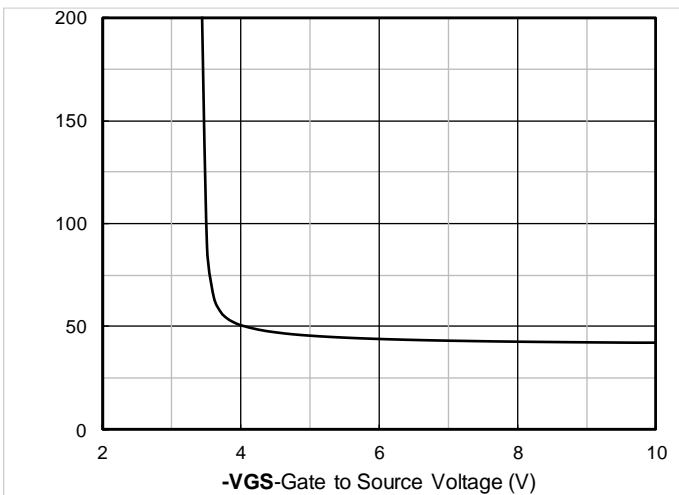

Figure 5. On-Resistance vs Gate to Source Voltage

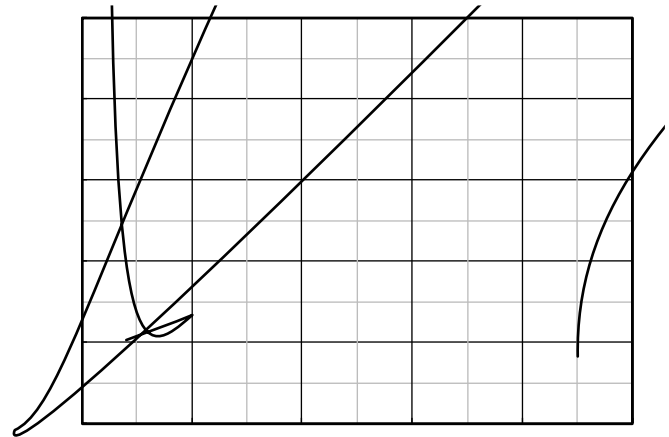

Figure 6. Normalized On-Resistance



YJD055P10A

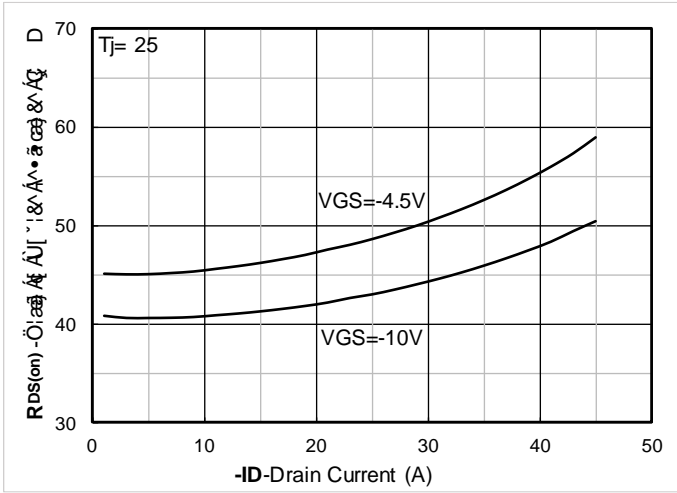

Figure 7. RDS(on) VS Drain Current

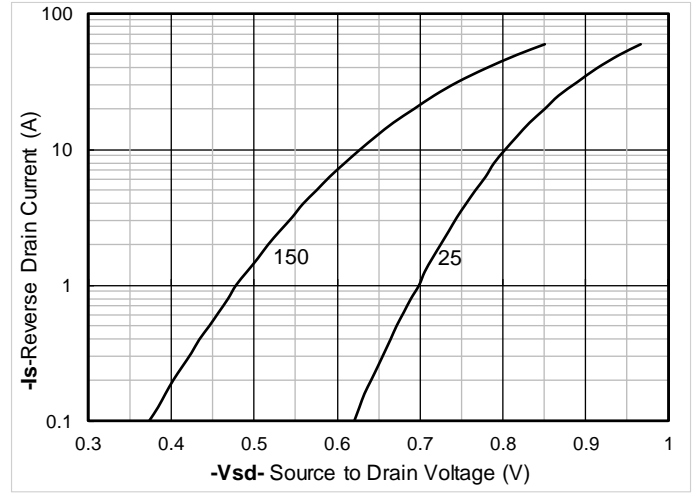

Figure 8. Forward characteristics of reverse diode

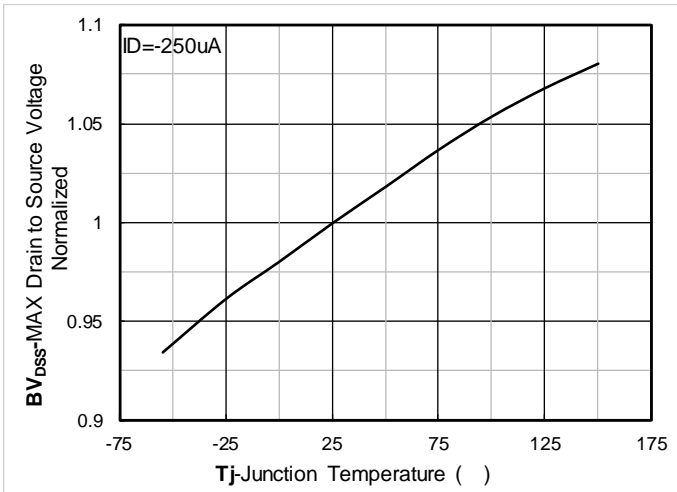

Figure 9. Normalized breakdown voltage

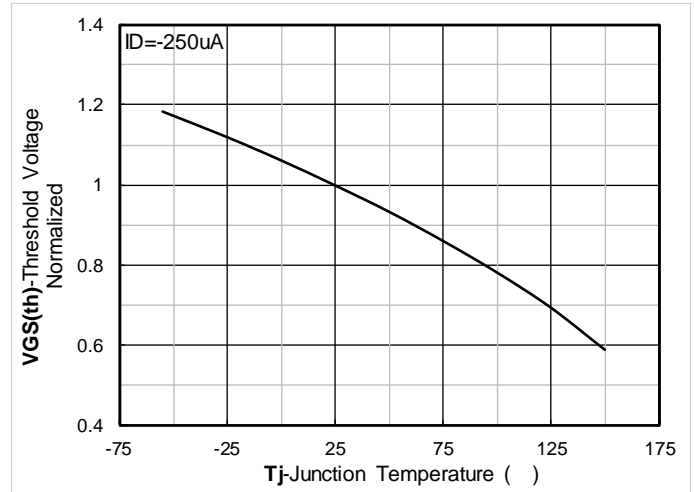

Figure 10. Normalized Threshold voltage

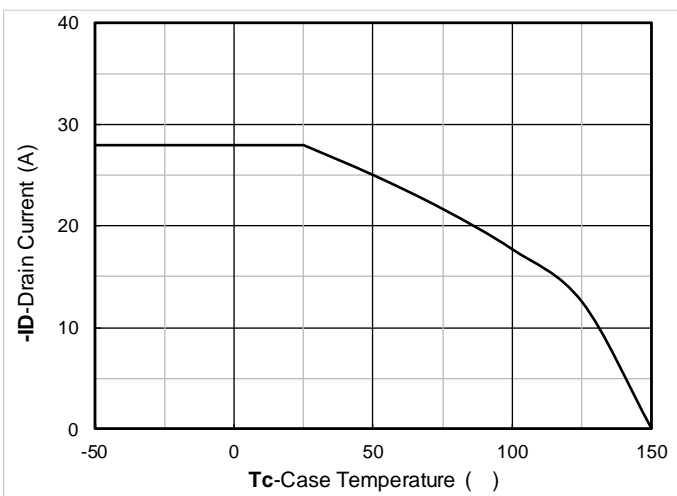

Figure 11. Current dissipation

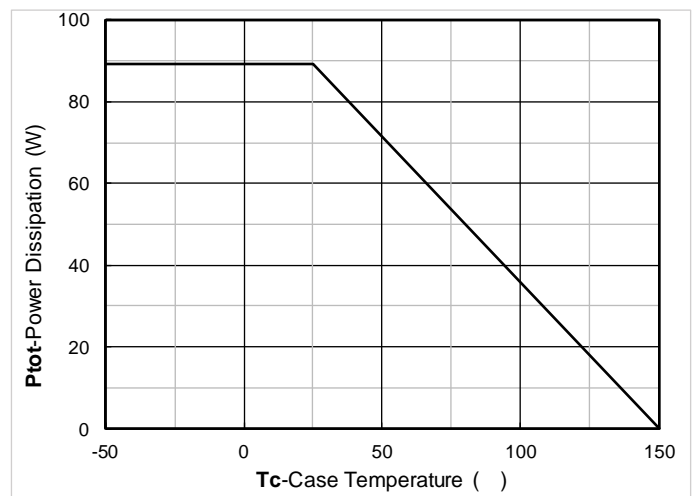

Figure 12. Power dissipation



YJD055P10A



Figure 13. Maximum Transient Thermal Impedance

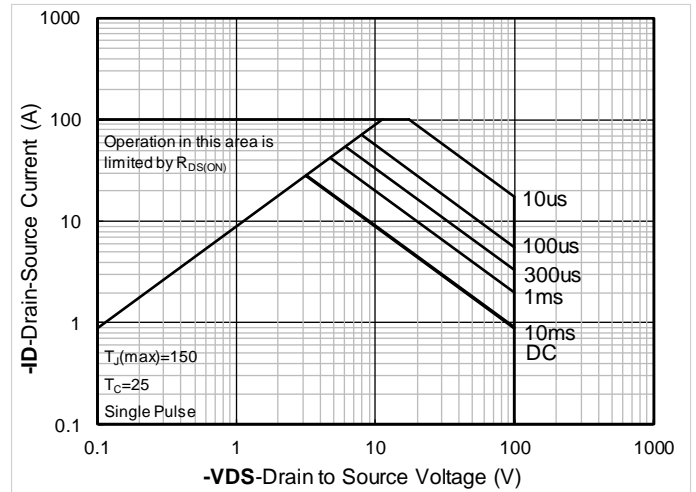
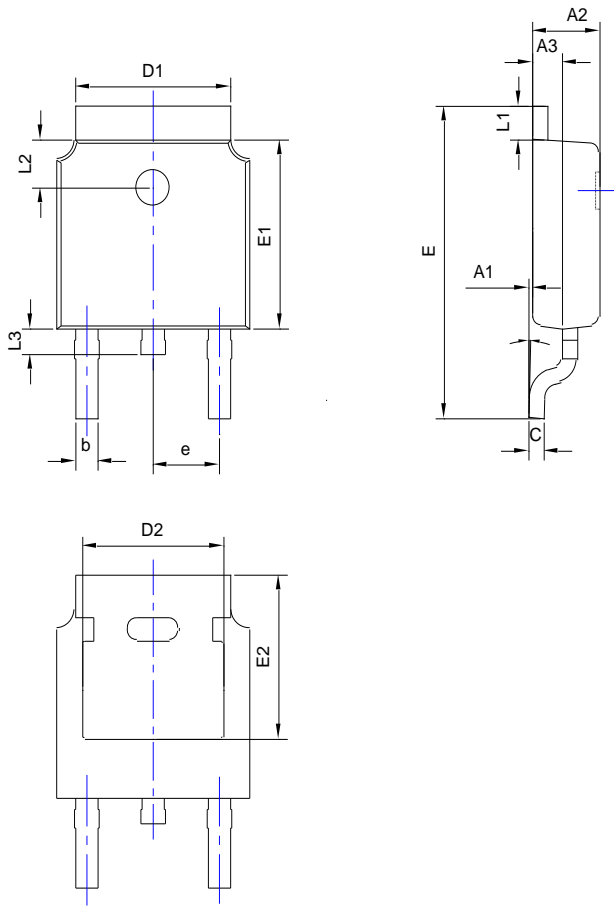

Figure 14. Safe Operation Area



YJD055P10A

TO-252-B Package information



SYMBOL	DIMENSIONS				
	INCHES				
	MIN.	NOM.			
A1	0.000				
A2	0.087	0.091			
A3	0.035	0.039			
b	0.026	0.030			
c	0.018	0.020			
D	0.256	0.260			
D1					
D2	0.181	0.189			
E	0.390	0.398			
E1	0.236	0.240			

NOTE:
1.PACKAGE BODY SIZES EXCLUDE MOLD FLASH AND GATE BURRS.
2.TOLERANCE 0.1mm UNLESS OTHERWISE SPECIFIED.
3.THE PAD LAYOUT IS FOR REFERENCE PURPOSES ONLY.

