



MD100S-M4



Glass Passivated Three Phase Rectifier Bridge

VRRM 800 to 1800V
ID 100 A

Applications

Three phase rectifiers for power supplies
 Rectifiers for DC motor field supplies
 Battery charger rectifiers
 Input rectifiers for variable frequency drives

Features

Three phase bridge rectifier
 Blocking voltage:800 to 1800V
 Heat transfer through aluminum oxide DBC ceramic isolated metal baseplate
 Glass passivated chip
 UL recognized applied for file no. E230084

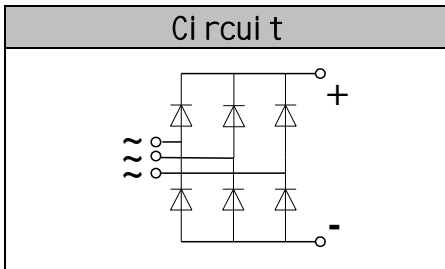

Module Type

TYPE	VRRM	VRSM
MD100S08M4	800V	900V
MD100S12M4	1200V	1300V
MD100S16M4	1600V	1700V
MD100S18M4	1800V	1900V

Maximum Ratings

Symbol	Conditions	Values	Units
ID	Three phase, full wave Tc=100	100	A
IFSM	t=10mS Tvj =45	1020	A
i ² t	t=10mS Tvj =45	5200	A ² s
Visol	a.c.50HZ;r.m.s.;1min	3000	V
Tvj		-40 to +150	
Tstg		-40 to +125	
Mt	To terminals(M5)	3±15%	Nm
Ms	To heatsink(M5)	3±15%	Nm
Weight	Module (Approximately)	146	g

Thermal Characteristics

Symbol	Conditions	Values	Units
Rth(j-c)	Per diode	1.0	/W
Rth(c-s)	Module (Approximately)	0.07	/W

Electrical Characteristics

Symbol	Conditions	Values			Units
		Min.	Typ.	Max.	
VFM	T=25 IF =300A		1.70	1.90	V
IRD	Tvj=25 VRD=VRRM			0.3	mA
	Tvj=150 VRD=VRRM			5	mA

Performance Curves

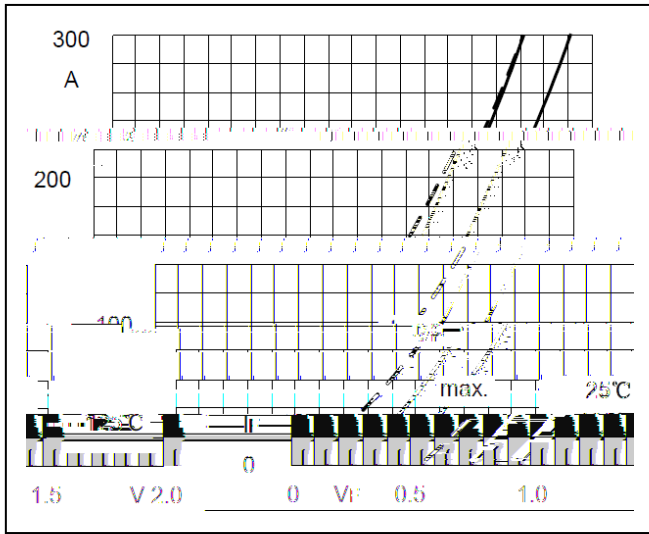

Fig1. Forward Characteristics

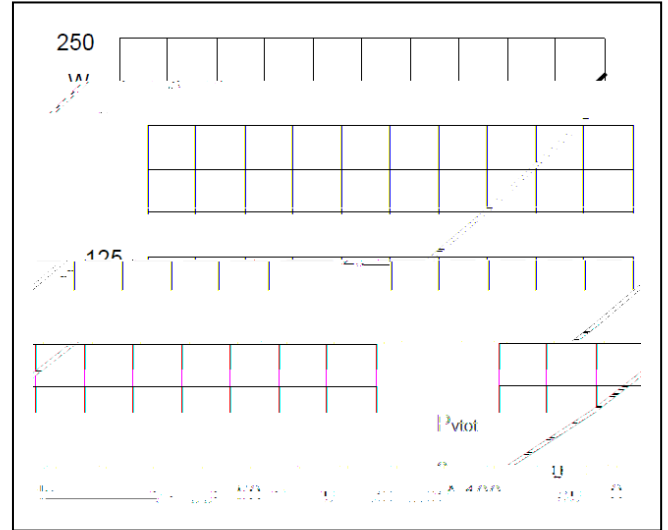

Fig2. Power dissipation

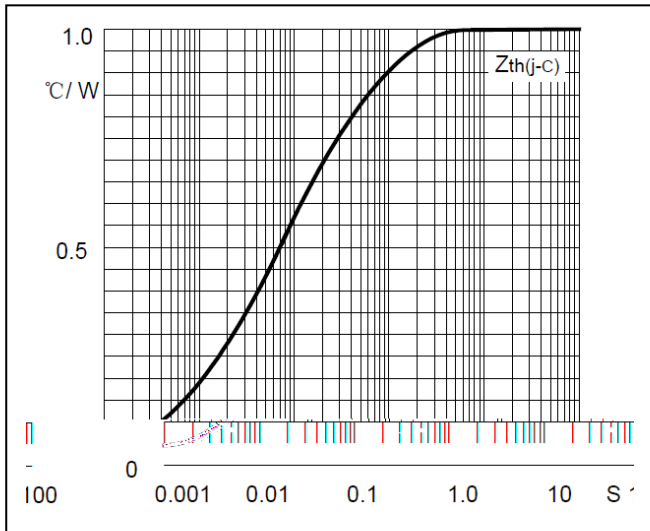

Fig3. Transient thermal impedance

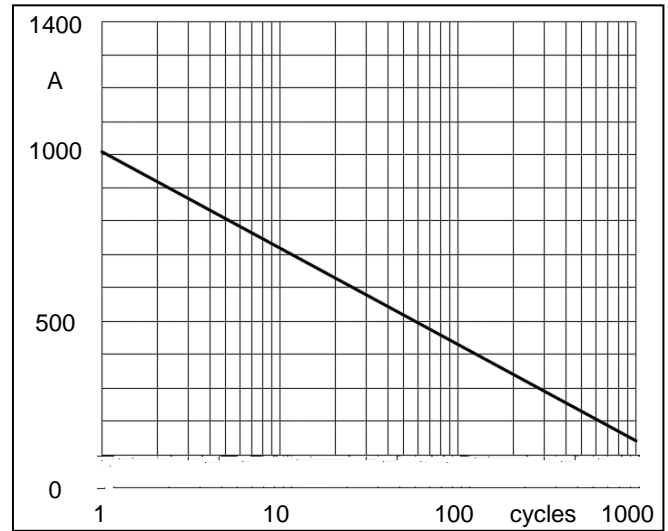

Fig4. Max Non-Repetitive Forward Surge Current

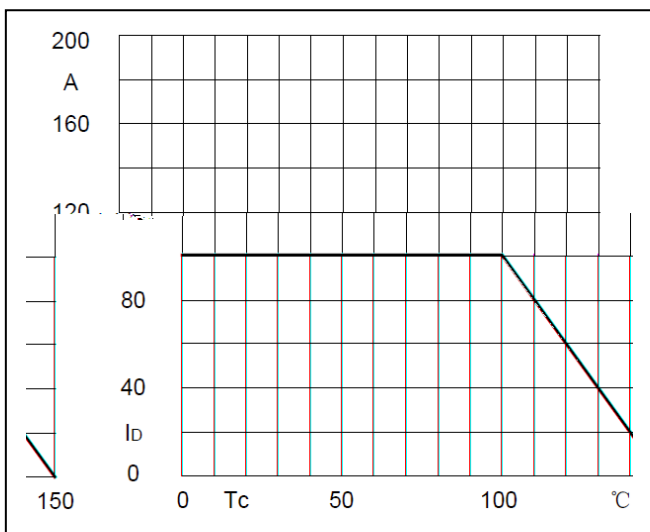
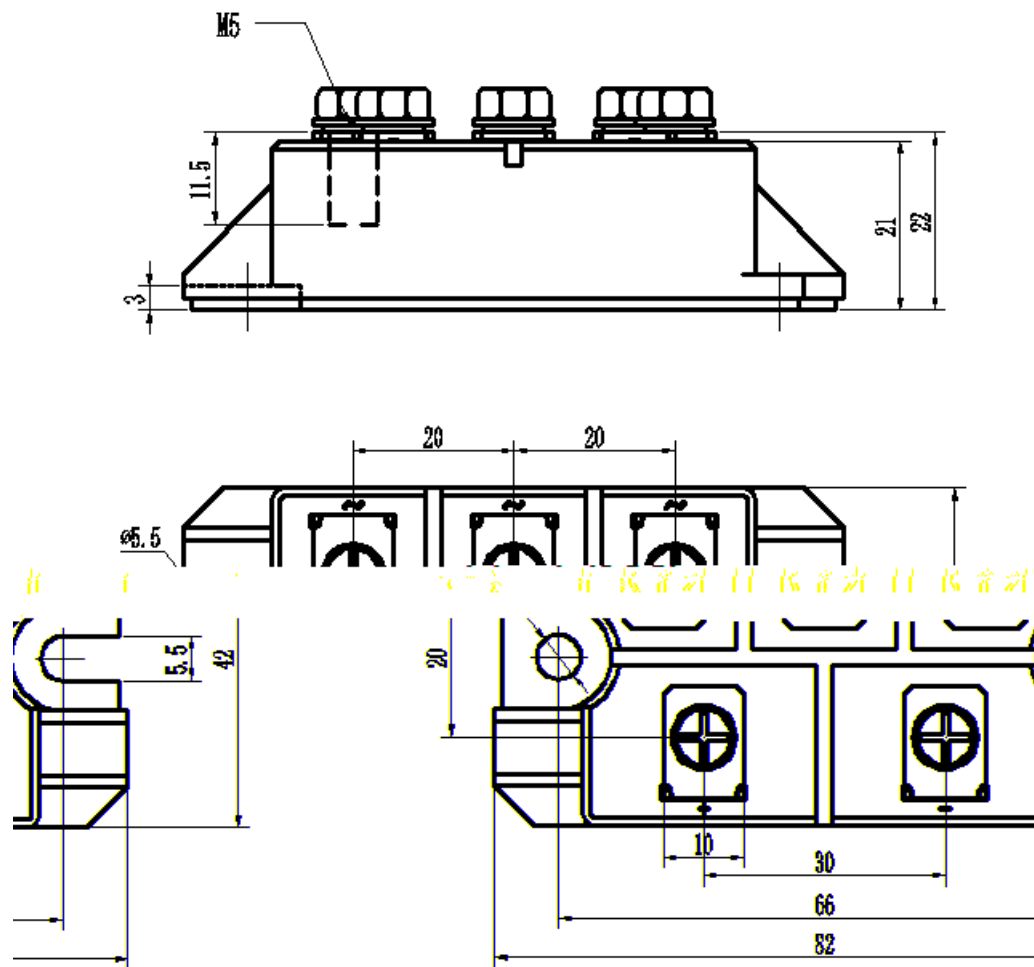

Fig5. Forward Current Derating Curve

Package Outline Information

CASE M4



Dimensions in mm